



SP1020 THRU SP10100

10 A Schottky Barrier Rectifiers

Voltage Range 20 to 100 Volts
Current 10.0 Amperes

Features

- * Low forward voltage drop
- * High current capability
- * High reliability
- * High surge current capability
- * Epitaxial construction

Mechanical Data

- * Case: Molded plastic
- * Epoxy: UL 94V-0 rate flame retardant
- * Lead: Axial leads, solderable per MIL-STD-202, method 208 guaranteed
- * Polarity: Color band denotes cathode end
- * Mounting position: Any
- * Weight: 2.24 grams

I/O-220

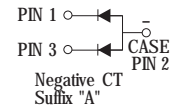
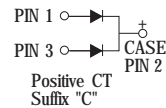
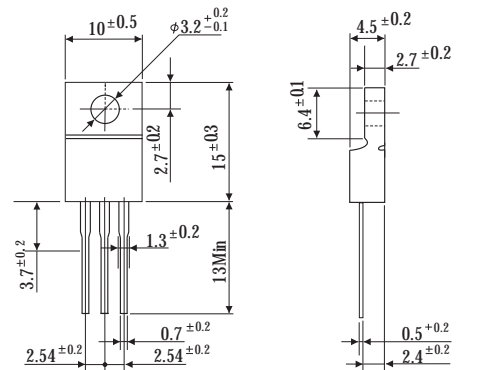

Dimensions in inches and (millimeters)

Maximum Ratings and Electrical Characteristics

Rating at 25°C ambient temperature unless otherwise specified Single phase, half wave, 60 Hz, resistive or inductive load. For capacitive load, derate current by 20%

Type Number	SP1020	SP1030	SP1040	SP1050	SP1060	SP1080	SP10100	Units
Maximum Recurrent Peak Reverse Voltage	20	30	40	50	60	80	100	v
Maximum RMS Voltage	14	21	28	35	42	56	70	v
Maximum DC Blocking Voltage	20	30	40	50	60	80	100	v
Maximum Average Forward Rectified Current See Fig. 1	10							A
Peak Forward Surge Current, 8.3 ms Single Half Sinewave - Superimposed on Rated Load method (JEDEC)	130				100			A
Maximum Instantaneous Forward Voltage @ 5.0A	0.65		0.75		0.85			V
Maximum D.C. Reverse Current @ T _A =25°C	1							mA
At Rated DC Blocking Voltage @ T _A =100°C	100							mA
Typical Junction Capacitance (Note 1)	700		460		280			pF
Typical Thermal Resistance R _{JA} (Note 2)	3.5							°C/W
Operating Junction Temperature Range T _J	-50+125							°C
Storage Temperature Range T _{STG}	-65+150							°C

Notes:

1. Measured at 1MHz and applied reverse voltage of 4.0Volts D.C.
2. Thermal Resistance Junction to Case



SP1020 THRU SP10100

10 A Schottky Barrier Rectifiers

Voltage Range 20 to 100 Volts
Current 10.0 Amperes

RATING AND CHARACTERISTIC CURVES (SP1020 THRU SP10100)

FIG.1-TYPICAL FORWARD CURRENT DERATING CURVE

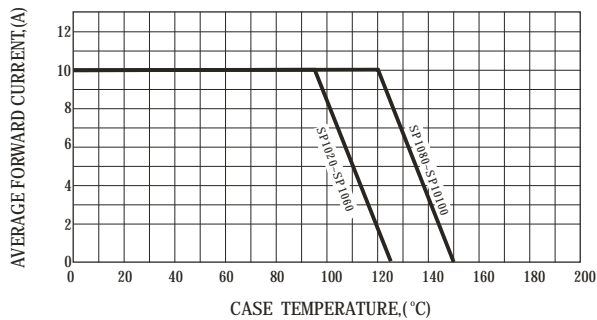

FIG.2-TYPICAL FORWARD CHARACTERISTICS

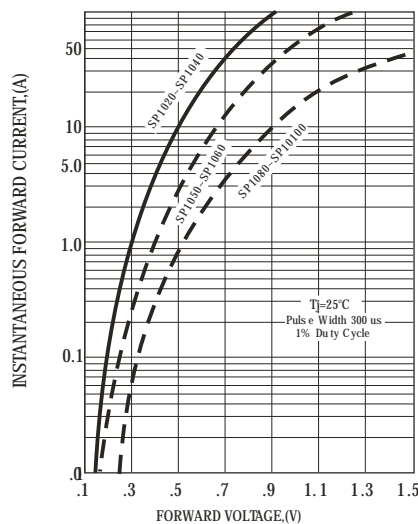

FIG.3-MAXIMUM NON-REPETITIVE FORWARD SURGE CURRENT

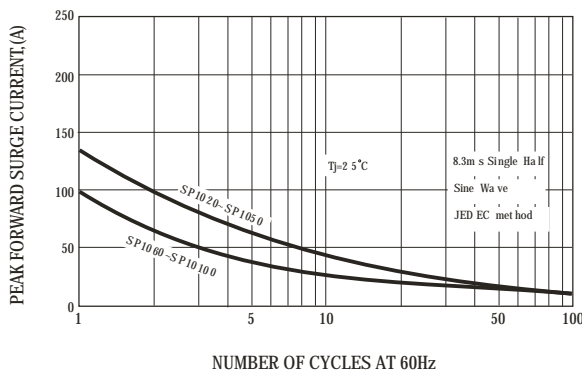

FIG.5 - TYPICAL REVERSE CHARACTERISTICS

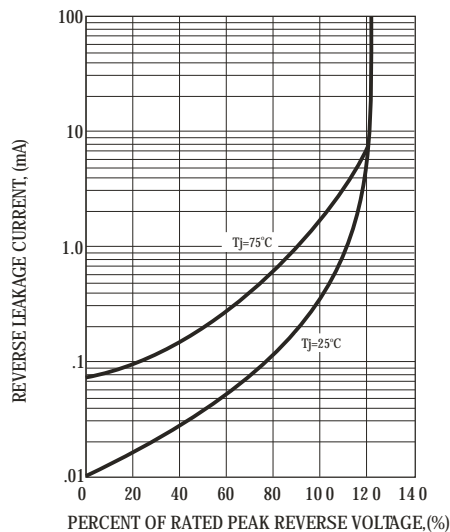

FIG.4-TYPICAL JUNCTION CAPACITANCE

